

# AMERICAN AUDIO



## PXI 10P™

**Powered Professional Two-Way  
Sound Reinforcement Loudspeaker**

**AMERICAN AUDIO**  
4295 Charter Street  
Los Angeles, Ca. 90058  
[www.AmericanAudio.us](http://www.AmericanAudio.us)  
Rev. 4/06

CUSTOMER SUPPORT.....	2
UNPACKING.....	2
HANDLING PRECAUTIONS.....	3
FEATURES.....	4
PRODUCT REGISTRATION.....	5
FRONT PANEL FEATURES.....	6
REAR PANEL CONTROLS.....	7
RIGGING AND MOUNTING.....	11
AVAILABLE ACCESSORIES.....	12
WARRANTY.....	13
SPECIFICATIONS.....	14

**Introduction:** Congratulations and thank you for purchasing the American Audio® PXI 10P™ professional sound reinforcement loudspeaker. This loudspeaker is a representation of American Audio's continuing commitment to produce the best and highest quality audio products possible at an affordable price. The PXI 10P™ is a 200 watt self powered, two-way active loudspeaker encased in a light weight ASB Nylon Fiber cabinet. This speaker has been designed to be used as both a portable and a permanently installed unit. The speaker includes a poll mount slot and rubber feet on the bottom of the unit for portable applications and also includes rigging points on the top, bottom, and rear of the unit for permanent and flight installations. Please read and understand this manual completely before attempting to operate your new speaker system. This booklet contains important information concerning the proper and safe operation of your new speaker.

**Customer Support:** American Audio® provides a toll free customer support line, to provide set up help and answer any question should you encounter problems during your initial set up or operation. You may also visit us on the web at [www.americandj.com](http://www.americandj.com) for any comments or suggestions. Service Hours are Monday through Friday 9:00 a.m. to 5:30 p.m. Pacific Standard Time.

Voice: (800) 322-6337  
 Fax: (323) 582-2610  
 E-mail: [support@americandj.com](mailto:support@americandj.com)

**Caution!** There are no user serviceable parts inside this speaker. Do not attempt any repairs, without being instructed to do so by an authorized American Audio technician. Doing so will void your manufacturer's warranty. In the unlikely event your speaker may require service, please contact American Audio®.

Every PXI 10P™ has been thoroughly tested and has been shipped in perfect operating condition. Carefully check the shipping carton for damage that may have occurred during shipping. If the carton appears to be damaged carefully inspect your units for any damage and be sure all accessories necessary to operate the system have arrived intact. In the event damage has been found or parts are missing, please contact our toll free customer support number for further instructions. Please do not return the speaker to your dealer without first contacting customer support.

## ELECTRICAL PRECAUTIONS



The lightning flash with arrowhead symbol, within an equilateral triangle, is intended to alert the user to the presence of uninsulated "dangerous voltage" within the product's enclosure that may be of sufficient magnitude to constitute a risk of electric shock to persons.



CAUTION: TO REDUCE THE RISK OF ELECTRIC SHOCK, DO NOT REMOVE THE COVER (OR BACK). THERE ARE NO USER SERVICEABLE PARTS INSIDE. REFER SERVICE TO YOUR AUTHORIZED AMERICAN AUDIO® SERVICE TECHNICIAN.



The exclamation point within an equilateral triangle is intended to alert the user to the presence of important operating and maintenance (servicing) instructions in the literature accompanying the appliance.

# IMPORTANT SAFETY INSTRUCTIONS

**READ INSTRUCTIONS** — All the safety and operating instructions should be read before the product is operated.

**RETAIN INSTRUCTIONS** — The safety and operating instructions should be retained for future reference.

**HEED WARNINGS** — All warnings on the product and in the operating instructions should be adhered to.

**FOLLOW INSTRUCTIONS** — All operating and use instructions should be followed.

**CLEANING** — The product should be cleaned only with a polishing cloth or a soft dry cloth. Never clean with furniture wax, benzene, insecticides or other volatile liquids since they may corrode the cabinet.

**ATTACHMENTS** — Do not use attachments not recommended by the product manufacturer as they may cause hazards.

**WATER AND MOISTURE** — Do not use this product near water — for example, near a bathtub, wash bowl, kitchen sink, or laundry tub; in a wet basement; or near a swimming pool; and the like.

**ACCESSORIES** — Do not place this product on an unstable cart, stand, tripod, bracket, or table. The product may fall, causing serious injury to a child or adult, and serious damage to the product. Use only with a cart, stand, tripod, bracket, or table recommended by the manufacturer, or sold with the product. Any mounting of the product should follow the manufacturer's instructions, and should use a mounting accessory recommended by the manufacturer.

**CART** — A product and cart combination should be moved with care. Quick stops, excessive force, and uneven surfaces may cause the product and cart combination to overturn.



**VENTILATION** — Slots and openings in the cabinet are provided for ventilation and to ensure reliable operation of the product and to protect it from overheating, and these openings must not be blocked or covered. The openings should never be blocked by placing the product on a bed, sofa, rug, or other similar surface. This product should not be placed in a built-in installation such as a bookcase or rack unless proper ventilation is provided or the manufacturer's instructions have been adhered to.

**POWER SOURCES** — This product should be operated only from the type of power source indicated on the marking label. If you are not sure of the type of power supply to your home, consult your product dealer or local power company.

**LOCATION** — The appliance should be installed in a stable location.

**NONUSE PERIODS** — The power cord of the appliance should be unplugged from the outlet when left unused for a long period of time.

### GROUNDING OR POLARIZATION

- If this product is equipped with a polarized alternating current line plug (a plug having one blade wider than the other), it will fit into the outlet only one way. This is a safety feature. If you are unable to insert the plug fully into the outlet, try reversing the plug. If the plug should still fail to fit, contact your electrician to replace your obsolete outlet. Do not defeat the safety purpose of the polarized plug.

- If this product is equipped with a three-wire grounding type plug, a plug having a third (grounding) pin, it will only fit into a grounding type power outlet. This is a safety feature. If you are unable to insert the plug into the outlet, contact your electrician to replace your obsolete outlet. Do not defeat the safety purpose of the grounding type plug.

**POWER-CORD PROTECTION** - Power-supply cords should be routed so that they are not likely to be walked on or pinched by items placed upon or against them, paying particular attention to cords at plugs, convenience receptacles, and the point where they exit from the product.

**OUTDOOR ANTENNA GROUNDING** — If an outside antenna or cable system is connected to the product, be sure the antenna or cable system is grounded so as to provide some protection against voltage surges and built-up static charges. Article 810 of the National Electrical Code, ANSI/NFPA 70, provides information with regard to proper grounding of the mast and supporting structure, grounding of the lead-in wire to an antenna discharge unit, size of grounding conductors, location of antenna-discharge unit, connection to grounding electrodes, and requirements for the grounding electrode. See Figure A.

**LIGHTNING** — For added protection for this product during a lightning storm, or when it is left unattended and unused for long periods of time, unplug it from the wall outlet and disconnect the antenna or cable system. This will prevent damage to the product due to lightning and power-line surges.

**POWER LINES** — An outside antenna system should not be located in the vicinity of overhead power lines or other electric light or power circuits, or where it can fall into such power lines or circuits. When installing an outside antenna system, extreme care should be taken to keep from touching such power lines or circuits as contact with them might be fatal.

**OVERLOADING** — Do not overload wall outlets, extension cords, or integral convenience receptacles as this can result in a risk of fire or electric shock.

**OBJECT AND LIQUID ENTRY** - Never push objects of any kind into this product through openings as they may touch dangerous voltage points or short-out parts that could result in a fire or electric shock. Never spill liquid of any kind on the product.

**SERVICING** — Do not attempt to service this product yourself as opening or removing covers may expose you to dangerous voltage or other hazards. Refer all servicing to qualified service personnel.

**DAMAGE REQUIRING SERVICE** - Unplug this product from the wall outlet and refer servicing to qualified service personnel under the following conditions:

- When the power-supply cord or plug is damaged.
- If liquid has been spilled, or objects have fallen into the product.
- If the product has been exposed to rain or water.
- If the product does not operate normally by following the operating instructions. Adjust only those controls that are covered by the operating instructions as an improper adjustment of other controls may result in damage and will often require extensive work by a qualified technician to restore the product to its normal operation.
- If the product has been dropped or damaged in any way.
- When the product exhibits a distinct change in performance — this indicates a need for service.

**REPLACEMENT PARTS** -- When replacement parts are required, be sure the service technician has used replacement parts specified by the manufacturer or have the same characteristics as the original part. Unauthorized substitutions may result in fire, electric shock, or other hazards.

**SAFETY CHECK** - Upon completion of any service or repairs to this product, ask the service technician to perform safety checks to determine that the product is in proper operating condition.

**WALL OR CEILING MOUNTING** — The product should not be mounted to a wall or ceiling.

**HEAT** — The product should be situated away from heat sources such as radiators, heat registers, stoves, or other products (including amplifiers) that produce heat.

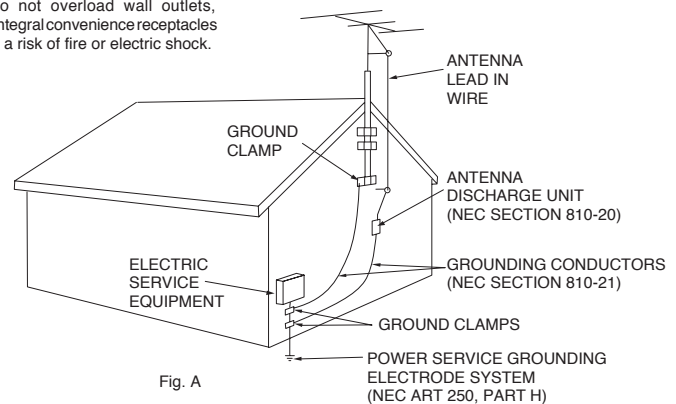

Fig. A

NEC — NATIONAL ELECTRICAL CODE

PXI 10P™ loudspeaker can easily reproduce sound pressure levels (SPL) sufficient enough to cause severe and permanent hearing damage. A great degree of care should be taken to protect your ears to prolong exposure to SPL in excess of 85dB.

- For adult use only - Keep out of the reach of children.
- Be sure all power is turned off before making speaker connections
- Do not remove the speaker cover or grill under any conditions
- Always use a power cord that meets the manufacturer's exact power specifications
- Disconnect from main power before making any type of connection
- To reduce the risk of electrical shock or fire, do not expose this unit to rain or moisture
- This speaker is intended for indoor use only, use of this product outdoors voids all warranties.
- Always mount this speaker in a safe and stable manner.
- Power Cord Protection - Power supply cords should be routed so that they are not likely to be walked on or pinched by items placed upon or against them, paying particular attention to cords at plugs, convenience receptacles, and the point where they exit from the speaker.
- Heat -The speaker should be situated away from heat sources such as radiators, heat registers, stoves, or other mixers (including amplifiers) that produce heat
- Be sure to save the packing carton in the event the unit needs to be returned for service
- Read all documentation before attempting to operate your new mixer. Please save all your documentation for future reference
- Do not spill water or other liquids in to or on to your speaker
- Be sure that the local power outlet matches that of the required voltage for your speaker.
- Do not attempt to operate this speaker if the power cord has been frayed or broken. Please route your power cord out of the way of foot traffic
- Always have the gain controls set to their lowest level during initial power-up to prevent speaker damage
- Servicing - The user should not attempt to service the speaker beyond that described in this manual. All other servicing should be referred to qualified service personnel. The speaker should only be serviced by qualified personnel when;
  - A. Objects have fallen, or liquid has been spilled into the speaker
  - B. The speaker has been exposed to rain or water
  - C. The speaker does not appear to operate normally or exhibits a change in performance
  - D. The terminal/cross-over plate has been damaged

**PXI 10P™ Speaker System:**

- Heavy Duty ASB Nylon Fiber Cabinet
- Built in XLR & 1/4" Mic and Line Level Inputs
- XLR and RCA Balanced Inputs
- Seperate Microphone Volume Control
- Electronic Crossover
- Built-in Rigging Points
- 1/4" and XLR Line Outputs
- Built-in Pole Mount Socket
- Bass and Treble Tone Controls
- Clip and Power LEDs
- 200 Watts
- Built-in Heavy Duty Carrying Handle
- Attached heavy Duty Rubber Feet

The PXI 10P™ carry a one year (365 days) limited warranty. Please fill out the enclosed warranty card to validate your purchase. All returned service items whether under warranty or not, must be freight pre-paid and accompany a return authorization (R.A.) number. The R.A. number must be clearly written on the outside of the return package. A brief description of the problem as well as the R.A. number must also be written down on a piece of paper and included in the shipping container. If the unit is under warranty, you must provide a copy of your proof of purchase invoice. You may obtain a R.A. number by contacting customer support at (800) 322-6337. All packages returned to the service department not displaying a R.A. number on the outside of the shipping package will be returned to the shipper unopened.

*The serial and model number for this unit is located on the rear panel Please write down the numbers here and retain them for future reference.*

Model No. \_\_\_\_\_

Date Purchased \_\_\_\_\_

Serial No. \_\_\_\_\_

Dealer Name \_\_\_\_\_



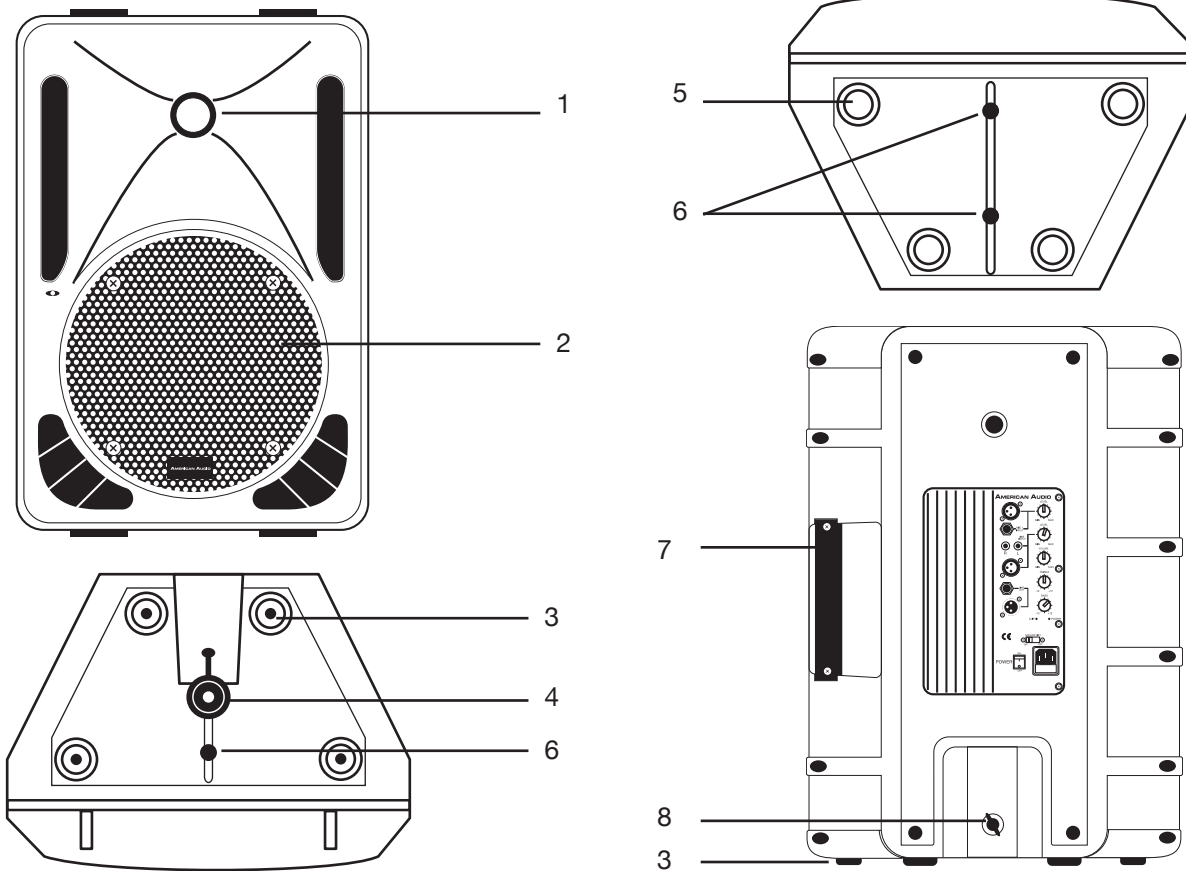

1. **HIGH FREQUENCY TRANSDUCER** – This unit is used to reproduce the high frequency response.
2. **10" WOOFER** – The high-powered 10" woofer is used to reproduce the midrange and low frequencies.
3. **RUBBER FOOT** – The speaker includes heavy-duty rubber feet on the bottom of the unit. These feet are used to secure a speaker to another when stacking. They are also used to secure the speaker to the ground to prevent it from shifting during heavy bass reproduction.
4. **POLE MOUNT SOCKET** – This socket is designed to fit a standard speaker pole mount or tripod such as the American Audio® SPS-1B speaker stand.
5. **STACKING NOTCHES** – These notches are designed to line up with the rubber feet of another PXI 10P™ and are used to support another speaker when they are stacked together.
6. **RIGGING POINTS** – The PXI 10P™ has four rigging points. These points are to be used to “fly” or suspend the speaker in the air by some means. Be sure to follow the “flying” outlines on page 15.
7. **TRANSPORT HANDLE** – The PXI 10P™ come with built-in heavy-duty transportation handle. Use this handle for secure and easy transportation.
8. **POLE MOUNT LOCKING PIN** – This pin is used to secure the speaker in place when mounting the speaker in a pole mount configuration. Always be sure to tighten down on the locking pin to prevent the speaker from shifting during use.

## Rear of PXI 10P™

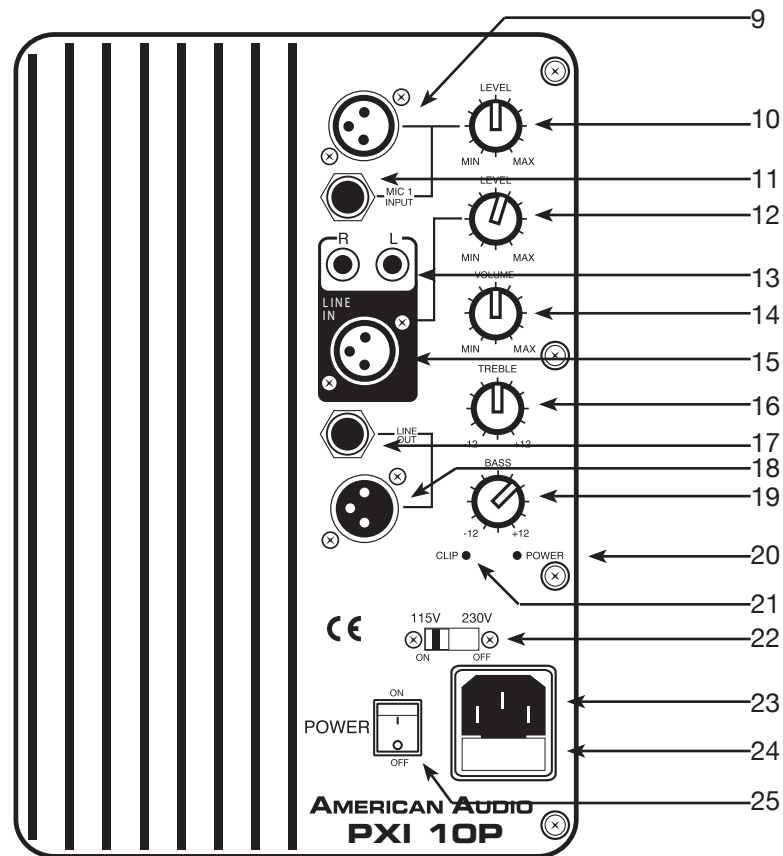
**Rear Panel:**

- 9. MIC 1/LINE LEVEL XLR INPUT JACK** - This jack is used for Microphone 1 and line level inputs. Connect CD players or Tape Decks to LINE inputs. Line level musical instruments with stereo outputs such as Rhythm Machines or Samplers should also be connected to the LINE inputs. **Do not connect mixers to this input, use the Balanced XLR or RCA Input (13 or 15) only!**
- 10. MICROPHONE 1/LINE LEVEL INPUT LEVEL** - This knob is used to regulate the output signal of the microphone or CD player/tape deck that is connected to the Mic/Line Level 1 jack (9 & 11).
- 11. 1/4" MIC 1/LINE LEVEL INPUT JACK** - This jack is used for a Microphone and line level inputs. Connect CD players or Tape Decks to LINE inputs. Line level musical instruments with stereo outputs such as Rhythm Machines, Keyboards or Samplers should also be connected to LINE inputs.
- 12. LINE LEVEL INPUT LEVEL** - This knob is used to regulate the output signal of the line level source connected to the Line Level Input Jacks (13 & 15).
- 13. BALANCED RCA LINE INPUT** - This connection is designed to accept a balanced line input signal from a mixer or other line level device with a balanced output jack. Use a balanced cable when the signal cable length exceeds 15 feet, this will reduce excessive signal loss. Be sure to connect only line level input devices such as mixers and tape machines to this jack.
- 14. OUTPUT VOLUME** - This knob is used to regulate the output signal being sent to another PXI 10P™ or other line level input jacks such as a mixer or power amp. (17 & 18).

**Rear Panel Cont.:**

- 15. BALANCED XLR LINE INPUT** – This connection is designed to accept a balanced line input signal from a mixer or other line level device with a balanced output jack. Use a balanced cable when the signal cable length exceeds 15 feet, this will reduce excessive signal loss. Be sure to connect only line level input devices such as mixers and tape machines to this jack.
- 16. TREBLE CONTROL** – This knob is used to regulate the amount treble applied to the output signal. The maximum amount of treble gain is +12dB and the maximum amount of treble decrease is -12dB. Turning the knob in a counter-clockwise direction will decrease the amount of treble applied to a channel signal, turning the knob in a clockwise direction will increase the amount of treble applied to a channel signal.
- 17. 1/4" LINE OUTPUT JACK** – This jack is used to send the incoming line level signal from either of the Line Level Inputs Jacks to another PXI 10P™ such as a mixer or power amp.
- 18. XLR PARALLEL OUTPUT JACK** – This jack is used to send the incoming line level signal from either of the Line Level Inputs Jacks to another PXI 10P™ or other line level input jack such as a mixer or power amp.
- 19. BASS CONTROL** – This knob is used to regulate the amount bass applied to the output signal. The maximum amount of bass gain is +12dB and the maximum amount of bass decrease is -12dB. Turning the knob in a counter-clockwise direction will decrease the amount of bass applied to a channel signal, turning the knob in a clockwise direction will increase the amount of bass applied to a channel signal.
- 20. POWER LED** - This L.E.D. will be lit when you switch on the power.
- 21. CLIP L.E.D.** - When your Mic 1, Line Level or Speaker Levels are distorted or too loud this L.E.D. will light letting you know to adjust your volume level to a lower setting.
- 22. GROUND LIFT** - Turn this switch "ON" to help to reduce noise feedback and interference.
- 23. MAIN POWER INLET** – This connector is used to supply main power to the unit via the included detachable power cord. The power connection uses an I.E.C. type connector, use only the supplied polarized AC power cord. Use only a power cord that matches this type of connection. Be sure to only connect this unit to a power outlet that matches the printed power label on the unit. Never use a power when the ground prong has been removed or broken off. The ground prong is used to reduce the risk of electrical shock in case of an electrical short. This cord is designed to fit in one direction only. Do not attempt to force a cord if it does not fit, be sure the cord is being inserted properly.
- 24. FUSE HOLDER** – This housing stores the 2.5 amp GMA protective fuse. Always replace with the exact same type fuse, unless otherwise instructed, by an authorized American Audio® service technician. Replacing with any other type of fuse than that of the recommended fuse will void your unit warranty.
- 25. MAIN POWER SWITCH** – This is the main power ON/OFF button. A green LED directly above the power switch will glow indicating power is ON. Before main power is applied, be sure you have made all connections to the speaker. Remember to avoid damaging pops to the speakers, the mixer is turned on first and turned off last.



Typical PXI 10P™ Output Set-Up

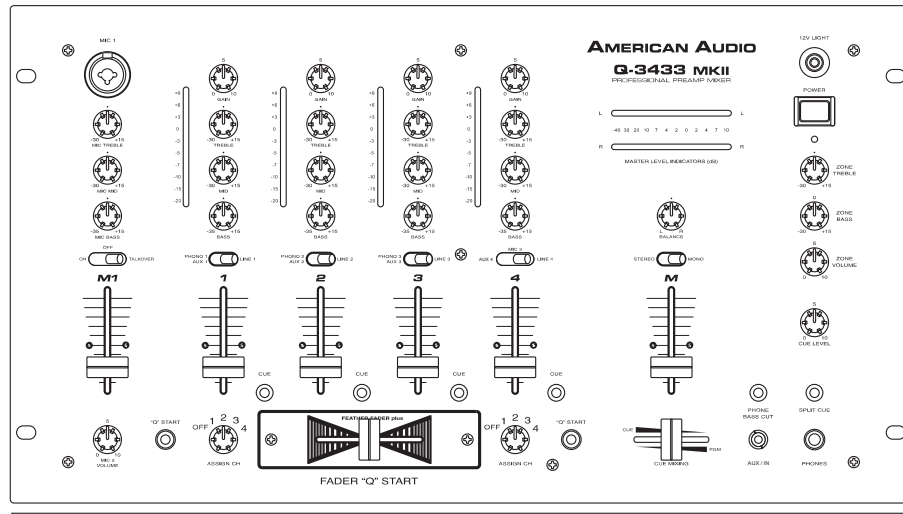

XLR-XLR Balanced Cables

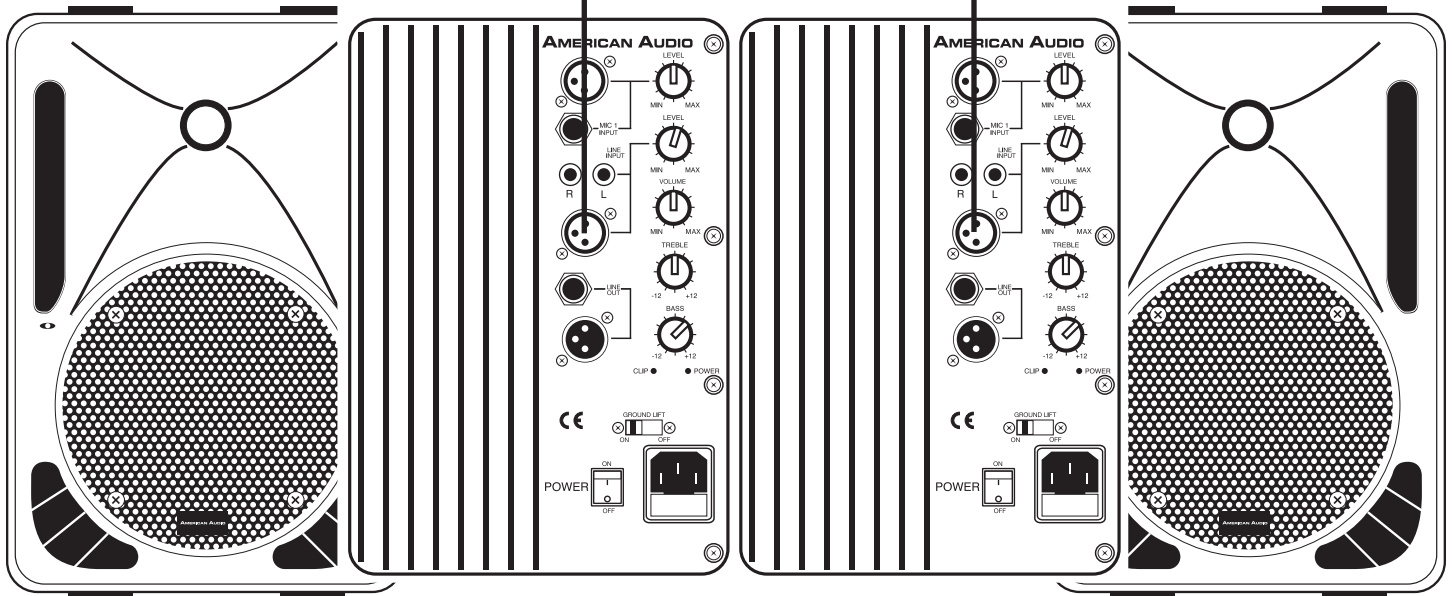

# PXI 10P™ Looping

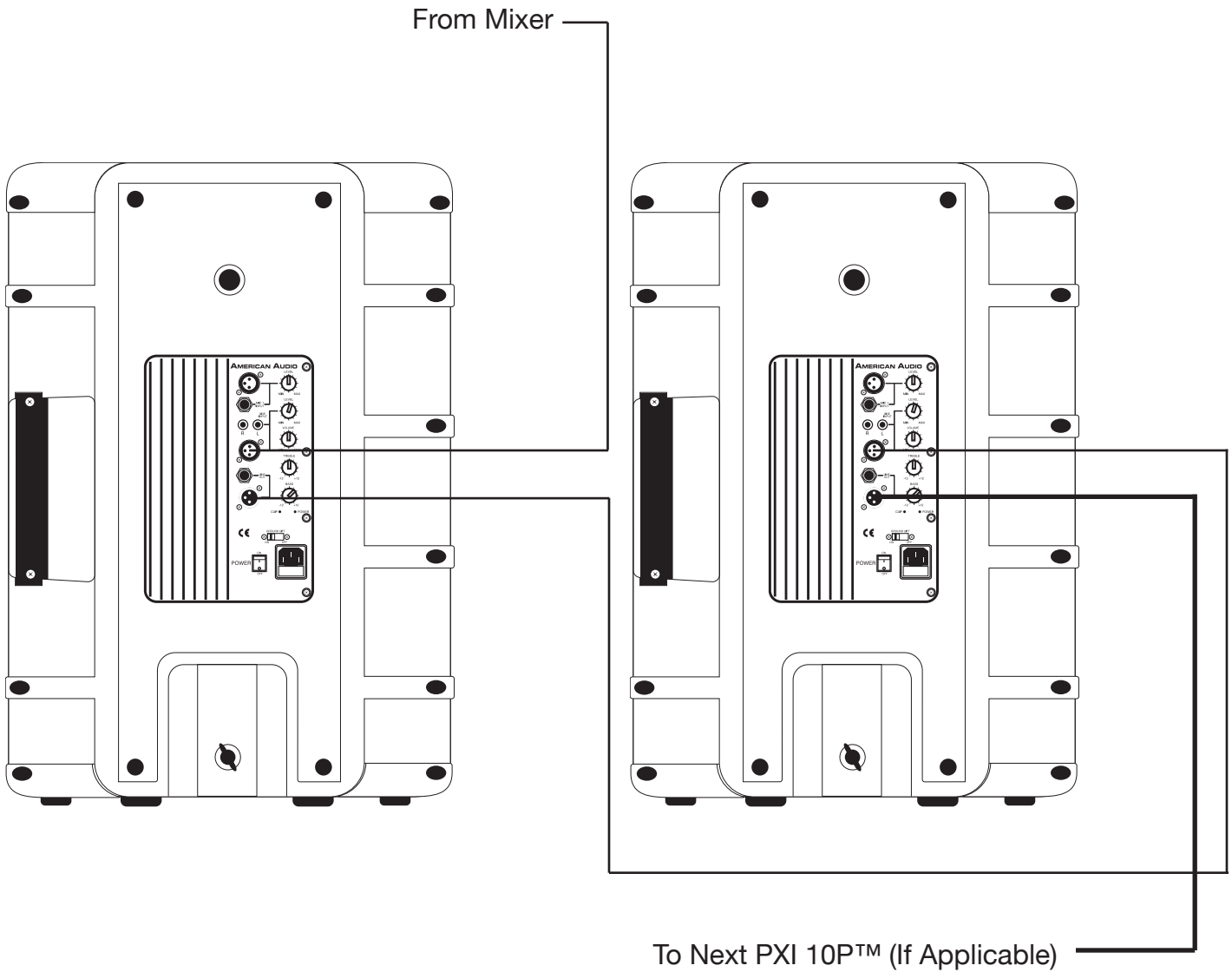

**Speaker Rigging Hardware** – The PXI 10P™ may be permanently installed or mounted using any of the many available third party wall brackets and ceiling mounts available. Always be sure to follow all safety instructions and guidelines included with the mounting hardware for safe and proper installation. American Audio® carries an assortment of rigging hardware specially designed to work with the PXI 10P™. The Z-APX/B is a heavy-duty bolt and may be used to secure the speaker to a cable or chain. The Z-APX/H is a heavy-duty eyebolt and is used to suspend or secure the speaker using safety cables. Please contact your dealer for more information and availability.

**Rigging Points** – The PXI 10P™ include four rigging points. These points are detailed on page six. The rigging points are used to “fly” or suspend the speaker in the air by some means.



**Pole Mounting** – The PXI 10P™ also include a pole mount option. The pole mount socket located on the bottom of the speaker may be used to secure the speaker to a speaker tri-pod, such as the American Audio® SPS-1B as illustrated on the left. Always be sure to follow the guidelines listed below when pole mounting your speaker;

- Always be sure the stand is designed to support the weight of the speaker
- In outdoor situations that are prone to windy conditions and strong wind gust, be sure to use sandbags as additional tri-pod support, this will greatly reduce the risk of tipping
- Do not stack speakers on top of each other when mounting on a tri-pod. Only one speaker should be mounted to a tri-pod at one time.
- Always position the tri-pod legs away from foot traffic
- Extend the tri-pod legs to their fully extended position to avoid accidental tipping
- Observe and follow all safety guidelines and regulations specified by the tri-pod’s manufacturer
- Be sure the tri-pod is situated on a flat, level, and stable surface
- Always tighten all tri-pod locks

**Pole Mount Locking Screw** – This screw is located on the rear of the speaker and is attached to the pole mount socket. Always use this screw to secure the speaker in place when mounting this speaker in a pole mount configuration. Always be sure to tighten down on this screw to prevent the speaker from shifting directions during use.

**Floor Monitor Brackets** - These brackets are helpful for DJ's and bands to help monitor their sound during a performance. This is also an alternative to standing the speaker straight up or mounting it on a stand. These brackets slide into each end of the speaker. Each speaker has its own special sized floor bracket.

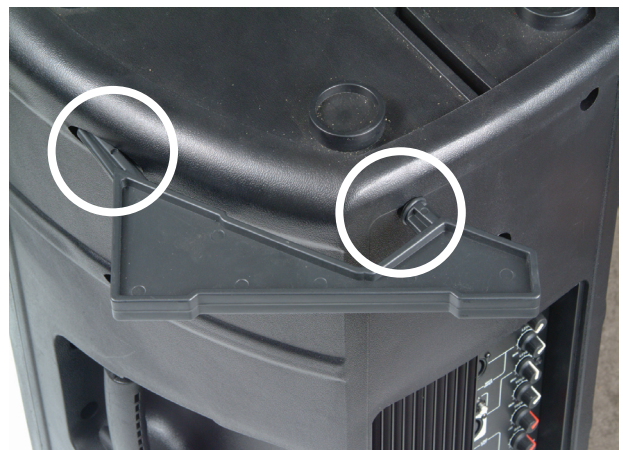

**Z-APX/B 7 Z-APX/H - Speaker Rigging Hardware -**

American Audio® carries an assortment of rigging hardware specially designed to work with the PXI 10P™. The Z-APX/B is a heavy-duty bolt and may be used to secure the speaker to a cable or chain. The Z-APX/H is a heavy-duty eyebolt and is used to suspend or secure the speaker using safety cables.



**SPS-1B - Speaker Stands** - American Audio® carries the SPS-1B speaker stand, which can be used to raise the speakers during use. The SPS-1B is a sturdy aluminum tri-pod and includes a mounting socket bracket for added security. The SPS-1B can raise the speaker to a maximum height of six feet and has a maximum weight capacity of 80 pounds. SPS-1B; weight = 6lbs, pipe diameter - 1 3/8"

**PXI BR10 - Wall Mounting Brackets** - This bracket is helpful for mounting the PXI 10P to a trussing setup or a wall. This is also an alternative to mounting it on a stand. These brackets bolt into the top and bottom of the speaker. Each speaker has its own special sized bracket.





**1-YEAR LIMITED WARRANTY**

- A. American Audio® hereby warrants, to the original purchaser, American Audio® products to be free of manufacturing defects in material and workmanship for a period of 1 Year (365 days) from the date of purchase. This warranty shall be valid only if the product is purchased within the United States of America, including possessions and territories. It is the owner's responsibility to establish the date and place of purchase by acceptable evidence, at the time service is sought.
- B. For warranty service, send the product only to the American Audio® factory. All shipping charges must be pre-paid. If the requested repairs or service (including parts replacement) are within the terms of this warranty, American Audio® will pay return shipping charges only to a designated point within the United States. If the entire instrument is sent, it must be shipped in its original package. No accessories should be shipped with the product. If any accessories are shipped with the product, American Audio® shall have no liability whatsoever for loss of or damage to any such accessories, nor for the safe return thereof.
- C. This warranty is void if the serial number has been altered or removed; if the product is modified in any manner which American Audio® concludes, after inspection, affects the reliability of the product; if the product has been repaired or serviced by anyone other than the American Audio® factory unless prior written authorization was issued to purchaser by American Audio®; if the product is damaged because not properly maintained as set forth in the instruction manual.
- D. This is not a service contract, and this warranty does not include maintenance, cleaning or periodic check-up. During the period specified above, American Audio® will replace defective parts at its expense, and will absorb all expenses for warranty service and repair labor by reason of defects in material or workmanship. The sole responsibility of American Audio® under this warranty shall be limited to the repair of the product, or replacement thereof, including parts, at the sole discretion of American Audio®. All products covered by this warranty were manufactured after January 1, 1990, and bear identifying marks to that effect.
- E. American Audio® reserves the right to make changes in design and/or improvements upon its products without any obligation to include these changes in any products theretofore manufactured.
- F. No warranty, whether expressed or implied, is given or made with respect to any accessory supplied with products described above. Except to the extent prohibited by applicable law, all implied warranties made by American Audio® in connection with this product, including warranties of merchantability or fitness, are limited in duration to the warranty period set forth above. And no warranties, whether expressed or implied, including warranties of merchantability or fitness, shall apply to this product after said period has expired. The consumer's and or Dealer's sole remedy shall be such repair or replacement as is expressly provided above; and under no circumstances shall American Audio® be liable for any loss or damage, direct or consequential, arising out of the use of, or inability to use, this product.
- G. This warranty is the only written warranty applicable to American Audio® Products and supersedes all prior warranties and written descriptions of warranty terms and conditions heretofore published.

**Model:** American Audio® PXI 10P™ - Professional  
Powered Sound Reinforcement Loud Speaker

**Speaker Section:**

**Dimensions:** 13.58" x 16.53" x 26.37" / 344mm x 419mm x 669mm  
**Weight:** 31 Lbs. / 14 kgs  
**Environmental conditions:** Operational temperature: 5 to 35°C (41 to 95°F)  
Operational humidity: 25 to 85% RH (non-condensation)  
Storage temperature: -20 to 60°C (4 to 140°F)  
**Frequency Response:** 40KHz - 20KHz (-3dB)  
**Crossover:** 3,500 HZ  
**Nominal Dispersion:** 90° x 50° (HXV)

**Amplifier Section:**

**Power supply:** AC 115v/230v, 50/60Hz  
**Power consumption:** 12 Watts Typical  
**Accessories:** I.E.C. Power Cord  
**Input Sensitivity**  
**Line:** 80mV  
**Microphone:** 5mV  
**Output Sensitivity:** 94 ± 2dB/m/w  
**Channel Equalizer:**  
**Bass:** +/-12dB  
**Treble:** +/-12dB

**NOTES:**

*The specifications are subject to change to any improvement by negotiations in advance.  
The parts are subject to change to any improvement within the range of the specifications.*

©American Audio  
A Division of the American DJ Group of Companies  
American Audio World Headquarters:  
4295 Charter Street  
Los Angeles, CA 90058 USA  
Tel: 323-582-2650 Fax: 323-582-2610  
Web: [www.AmericanAudio.us](http://www.AmericanAudio.us) E-mail: [info@AmericanAudio.us](mailto:info@AmericanAudio.us)